



Outback S-Lite **User Guide**

Part No. 875-0194-000 Rev D1

This device complies with part 15 of the FCC Rules. Operation is subject to the following two conditions:

- (1) This device may not cause harmful interference, and
- (2) this device must accept any interference received, including interference that may cause undesired operation.

Copyright Notice

Copyright AgJunction, Inc. (2013). All rights reserved.

No part of this manual may be reproduced, transmitted, transcribed, stored in a retrieval system or translated into any language or computer language, in any form or by any means, electronic, mechanical, magnetic, optical, chemical, manual or otherwise, without the prior written permission of AgJunction, Inc.

Trademarks

AirStar™, AirTrac™, AutoMate™, Bantam™, BaseLineHD™, BaseLineX™, eDrive®, eDriveTC™, eDriveVS™, eDriveX™, G4™, HQ™, IntelliFlow®, IntelliGate™, IntelliStar™, IntelliTrac™, Just Let Go™, LiteStar II™, M3™, MapStar®, Outback™, Outback 360™, Outback Guidance Center™, Outback Guidance®, Outback Hitch™, Outback MAX™, Outback S™, Outback S2™, Outback S3™, Outback S-Lite™, Outback Sts™, Outback STX™, Outback Steering Guide™, Satloc®, and the Satloc logo are proprietary trademarks of AgJunction, Inc. Other trademarks are the properties of their respective owners.

Patents

AgJunction, Inc. products may be covered by one or more of the following patents:

<u>U.S. Patents</u>				<u>Australia Patents</u>	
6111549	6876920	7400956	8000381	8214111	2002244539
6397147	7142956	7429952	8018376	8217833	2002325645
6469663	7162348	7437230	8085196	8265826	2004320401
6501346	7277792	7460942	8102325	8271194	
6539303	7292185	7689354	8138970	8307535	
6549091	7292186	7808428	8140223	8311696	
6711501	7373231	7835832	8174437	8334804	
6744404	7388539	7885745	8184050	RE41358	
6865465	7400294	7948769	8190337		

Other U.S. and foreign patents pending.

Dealer Support

Contact your local dealer for technical assistance. To find the authorized dealer near you:

Phone: (800) 247-3808

outbacksales@outbackguidance.com

Outback Guidance Technical Support

If you need to contact Outback Guidance Customer Service:

North America

Outback Guidance
AgJunction
2207 Iowa Street
Hiawatha, KS 66434
Phone: (800) 247-3808
Fax: (785) 742-4584

outbackCS@outbackguidance.com

Australia

Outback Australia
Unit 2, 305 Montague Road
West End, QLD 4101
Phone: (07) 3004 6789
Fax: (07) 3004 6799
outbackAUCS@outbackguidance.com

Outback Canada
326 Saulteaux Crescent
Winnipeg, MB R3J 3T2
Phone: (866) 888-4472
Fax: (204) 888-0991

Contents

Safety	1
Important Safety Information	2
Role of Operator	2
Manual Override	2
Tractor Overturns	2
Collisions with People and Objects	2
Operator Position	2
Installing Outback S-Lite	2
Mounting the Console	3
Attaching the Battery	3
Operating S-Lite	3
Chapter 1 Introduction	5
Product Overview	6
What's Included	6
Chapter 2 Getting Started	9
Installing S-Lite	10
Mounting the Antenna	10
Mounting the Console	11
Routing the Antenna Cable	12
Powering S-Lite	12
Configuring S-Lite	14
Using the Menu	14
Setup Menu	14
Service Menu	15
Chapter 3 Using Guidance Features	17
Guidance Overview	18
Status Indicators	19
Main Run Display Screens	20
Additional Display Screens	20
Using Straight Guidance	21
Setting the A=B Line	21
Adjusting the A=B Line	22
Using Contour Guidance	23
Guiding on Subsequent Passes	23
Making A New First Pass	23
Calculating the Area of a Field	24
Stopping Guidance	25

	Hold Logging Data/Guiding	25
	Return Here	25
	Return to Previous Point	26
	Update e-Dif	26
	Erase Memory	26
Chapter 4	Differential Correction Types	27
	Differential Corrections Overview	28
	Using e-Dif	29
	Selecting e-Dif	29
	Power On Initialization and DGPS Lock	29
Chapter 5	Communicating with Third Party Applications ..	31
	Available Applications	32
	Changing Default Settings	32
Appendix A	Troubleshooting	33
	Diagnostics	34
	Troubleshooting	35
	Testing Antenna Voltage	36
	Checking the DGPS Position by Verifying the BER	36
Appendix B	Menu Map	37
	End User License Agreement	41
	Warranty Notice	44



Safety

This section describes hazardous situations that, if not avoided, may result in death or serious injury. These safety messages provide information to identify a hazard associated with potential injury, and tell you how to avoid it.

These safety warnings apply whenever you use Outback S-Lite.

Read and understand this user guide and all the safety information in this section before installing, operating, or performing maintenance or service on Outback S-Lite. Do not allow anyone to operate without instruction.

If you have a question or need assistance, contact your local dealer or Outback Guidance Customer Service (see the front of this manual for contact information).

Keep this user guide and all related safety information with the manuals for your tractor and other implements.

Important Safety Information

Role of Operator

As with other navigation guidance systems within vehicles, the operator must still pay attention to driving the vehicle. To avoid serious injury or death, operators should not be distracted by other tasks and should be prepared to respond to field conditions. The operator must stay seated while the vehicle is moving.

Manual Override

The operator must stop following the path displayed by Outback S-Lite if it is unsafe to proceed, such as when an obstacle is in the line of travel or there is an emergency. Outback S-Lite cannot identify obstacles or hazards in the field, only the operator can do this. To stop following the displayed path, depress the brake or turn the steering wheel in either direction.

Tractor Overturns

Overturns account for the largest number of agricultural vehicle-related fatalities each year on farms. Overturns are more likely to occur on slopes. Outback S-Lite cannot identify environments that pose an increased risk of overturn, only the operator can do this.

Collisions with People and Objects

The second leading cause of agricultural vehicle-related fatalities occurs when vehicles run over people. Outback S-Lite cannot identify bystanders or other objects, such as trees, fences, boulders, and other equipment. The operator must stop following the path indicated by Outback S-Lite to avoid people and objects.

Operator Position

You must manually control the direction and speed of the tractor. Always remain in the operator's position in the tractor when using Outback S-Lite.

Installing Outback S-Lite

Before installing Outback S-Lite inspect the vehicle and perform any needed maintenance, such as a loose steering wheel, wheels out of alignment, uneven tire

pressure, and contaminated hydraulic fluid. Outback S-Lite may not perform as intended on a vehicle that is not properly maintained. Errors in vehicle performance while following Outback S-Lite guidance increase the risk of operator and bystander injury or death.

Turn off the vehicle and disengage the Outback S-Lite when installing or performing maintenance.

Before attempting to install any Outback S-Lite components, park the vehicle on a clean level floor with adequate clearance to work all around. Use an appropriate ladder or platform when installing or performing maintenance on cables, the antenna and other components of the Outback S-Lite.

Before you perform any drilling, cutting or fastening, ensure that no other vehicle components, such as electrical wiring, will be damaged. Failure to follow this warning may cause physical injury and/or damage to the machine.

To avoid burns or electric shock injury when installing or removing the Outback S-Lite, do not touch parts of the vehicle that are heated or electrically energized.

Mounting the Console

Mount the Outback S-Lite console where it can be seen clearly and is within reach. Do not place in a location where it interferes with seeing other information, controls, or the field. Looking at the screen for too long while operating the vehicle can cause a crash.

Attaching the Battery

Avoid contact with cables that carry high current. Connect the Outback S-Lite power cables to a stable 12-volt power supply.

Operating S-Lite

To avoid serious injury or death be prepared to respond to field conditions. Do not become distracted by other tasks.

Always pay attention to the task of driving the vehicle and stay seated while the vehicle is in motion.



Chapter 1: Introduction

Product Overview
What's Included

Product Overview

The Outback S-Lite™ introduces a new level of value and performance to the Outback Guidance® product family. The new design combines the market-proven Outback S™ simplicity together with the latest developments in Hemisphere Crescent® GPS receiver technology. This powerful combination will be the platform for years of future upgrades and additions.

- If you are a **first time user of Outback products**, acquaint yourself with the instructions contained in this manual. You will find many useful tips and suggestions to help you get the most from your investment.
- If you are an **experienced Outback S user**, you will find the new Outback S-Lite user interface very familiar and immediately appreciate the numerous enhancements that have been made. Outback Guidance suggests you acquaint yourself with these new features.

What's Included

Figure 1-1 shows the parts that comprise S-Lite and Table 1-1 provides part numbers and descriptions.



Figure 1-1: S-Lite parts

Table 1-1: S-Lite parts list

Item	Part No.	Description	Qty
A	150-1013-000#	Antenna, 1575.42 MHz	1
B	054-0100-000#	CLA power adapter cable	1
C	051-0167-000#	Power/ground speed (PWR/GSI) cable	1
D	601-0003-005#	Disk, zinc, 3-3/8" diameter, 3/16" thick	1
E	604-0019-000#	RAM mount (console mounting hardware)	1

Table 1-1: S-Lite parts list (continued)

Item	Part No.	Description	Qty
F	803-0051-000#	GPS receiver (console)	1
Not shown	683-0001-008#	Foam pad, circular, 3" diameter, 0.045" thick	1
	675-1123-000#	Screw, machine, 8-32, 7/16"	4
	875-0194-000	Outback S-Lite User Guide	2
	875-0195-000	Outback S-Lite Quick Reference Guide	2



Chapter 2: Getting Started

Installing S-Lite
Powering S-Lite
Configuring S-Lite

Before using S-Lite for the first time, complete the following tasks:

- Installing S-Lite
- Powering S-Lite
- Configuring S-Lite

Installing S-Lite

Correct installation of S-Lite is critical for safe and correct operation. Correct installation includes determining the location to install components as well as the actual installation of them and the routing of associated cabling. Components that you need to correctly locate, install, and route are the antenna, the console, the antenna cable, and the power cable.

Mounting the Antenna

Make sure to install the antenna in a location that will optimize its performance. It should be centered (left and right) on the vehicle as high and as far forward as possible, usually along the leading edge of the vehicle cab. Do not place the antenna within 2 feet of a transmitting radio antenna (such as a 2-way or business band radio).

1. Clean and dry the surface where the antenna mounting plate will be attached.
2. Remove the paper backing from one side of the adhesive disk and attach to the back of the antenna mounting plate.
3. Remove the paper backing from the other side of the adhesive on the mounting plate.
4. Position the mounting plate and press down hard for good adhesion.
5. Place the magnetic mounted antenna on the plate and be sure it is on the exact centerline of the vehicle.

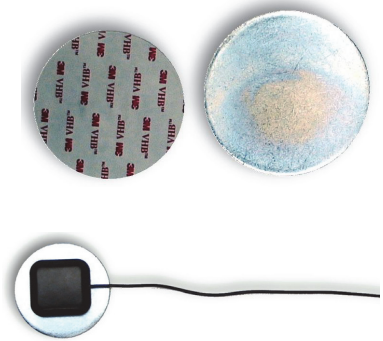

Mounting the Console

Normally, you mount the S-Lite console above and behind the center of the steering wheel just below the driver's line of sight. The easiest installation is on the front glass of the cab. If this is not possible, you can vacuum mount the assembly to any non-porous (metal) surface.

To mount the console:

1. Attach the RAM ball mount securely to the back of the S-Lite console.



2. Install the RAM pedestal to the vacuum cup using the two self-tapping screws provided. Tighten the screws securely.



3. Attach the RAM pedestal to the RAM ball on the back of the S-Lite console.



4. Thoroughly clean the inside cab window surface directly in front of the steering wheel.
5. Press the vacuum mount to the window and twist the actuator until it clicks over center to create adhesion to the glass.
6. Loosen the RAM mount and adjust the console to the proper viewing angle.



Note: Do not leave the console unattended for extended periods of time. If possible, remove the console from the glass when it is not in use. Continued exposure to the elements (such as direct sunlight) may damage the suction cup. To extend the life of the suction cup clean it periodically per manufacturers instructions.

Routing the Antenna Cable

Always power off the console before attaching or removing cables.

1. Route the cable to a cab opening where rubber protection exists that will protect the cable (a closed window works fine).

Note: Do not bend the cable to a radius of less than 6 inches. Avoid routing it within 12 inches of radio wires, power generator wires, a heat source, or moving parts.



2. Attach the end of the cable to the console.
3. Coil excess cable in a protected location and secure the installation with tie straps.

Powering S-Lite

There are two methods of providing power for S-Lite:

- You can connect the standard power cable directly to a compatible rate controller speed sensor port.

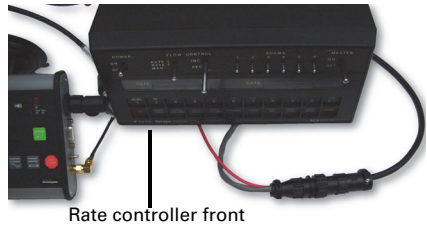

Rate controller back

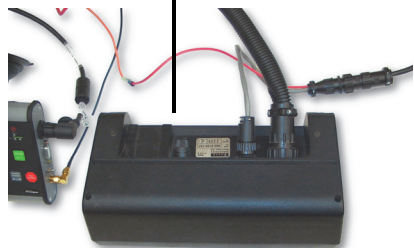

- You can attach the provided CLA adapter to power S-Lite from a 12 VDC power port. The standard power cable supplied with the S-Lite is compatible with rate controllers that require a Dickey John speed sensor connection. An optional cable is available from Outback Guidance to allow connection to rate controllers that require a Raven speed sensor connection.



To power S-Lite:

1. Connect the power cable to the console at the PWR/GSI port.
2. Twist the connector firmly until it snaps into place.
3. Connect the power cable to the power supply, either from your rate controller or 12 VDC power port.
4. Coil excess cable in a protected location and secure the installation with tie straps.

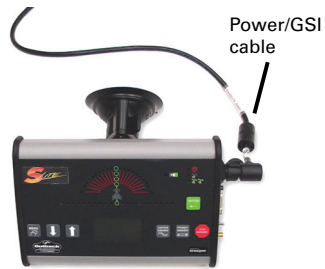

Note: Cigarette lighter sockets may provide intermittent power. For permanent installations, Outback Guidance recommends removing the cigarette lighter plug and hard-wiring the leads to a reliable 12 V power supply. Call Customer Service at 1-800-247-3808 before cutting any cables.

5. Toggle the power switch located on the right end of the console. S-Lite will complete an LED self test after which the RED LED illuminates indicating No Signal.

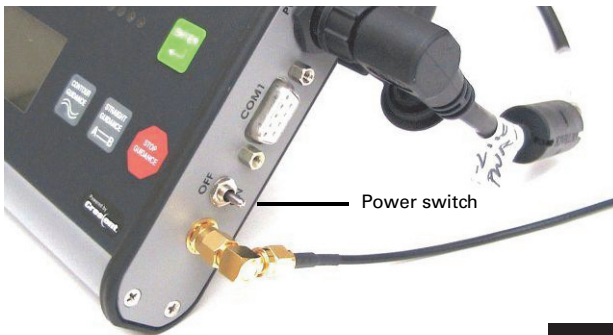

S-Lite automatically begins acquiring a DGPS signal. This process may take a few minutes. During this process, the vehicle can be moving or the operator can perform menu functions. Upon achieving a GPS signal, the YELLOW LED illuminates. Finally, once S-Lite has acquired a DGPS correction signal, the GREEN LED illuminates. The GREEN DGPS LED must be illuminated for S-Lite to provide guidance.

Note: The antenna must have a clear view of the sky to acquire a DGPS signal.

Configuring S-Lite

You configure S-Lite by setting various values in the Setup menu and Service menu.

Using the Menu

1. To access the menu, press the MENU button.
2. Select an item by using the UP ARROW and DOWN ARROW buttons. The ">" character points to the active menu item.
3. Press the ENTER button to select.

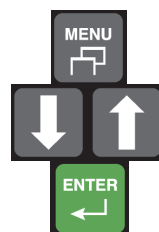

Setup Menu

Setup Menu	
Brightness	5
Swath Width	30.00
Sensitivity	Medium
Perimeter Setup	Right
Diagnostics	>
Service Menu	>

Menu Item	Display Sequence	Default	Description
Brightness	Brightness > 5	[1 to 10] Default = 5	Adjusts the display brightness. 1 is dim, 10 is bright. The LEDs also brighten or dim as you adjust this setting.
Swath Width	Swath Width > 30.00 ft	[3.4 ft to 3280.67 ft] Default = 30.00 ft	Adjust this number to equal the width of the implement or boom.
Sensitivity	Sensitivity >Medium	[Low, Medium, High] Default = Medium	Adjust the manual guidance indicator sensitivity to LOW, MEDIUM, or HIGH.
Perimeter Setup	Perimeter Setup >Right	[Left, Center, Right] Default = Right	Select RIGHT, CENTER, or LEFT edge of swath width for field perimeter area calculation (see "Calculating the Area of a Field" on page 24).
Diagnostics	See "Diagnostics" on page 34.		
Service Menu	See "Service Menu" on page 15.		

Service Menu

Service Menu	
Correction Type	SBAS
SBAS Satellite	AUTO
NMEA Port Setup	>
Unit of Measure	Feet
Language	English
Reset Defaults	>

Menu Item	Display Sequence	Defaults	Description
Correction Type	Correction Type >SBAS	[SBAS, e-Dif] Default = SBAS	See Chapter 4, "Differential Correction Types."
SBAS Satellite	SBAS Satellite >AUTO	[AUTO, W122, W134, W135, W138, E120, E124, E126, E131, M129, M137] Default = AUTO	Optional menu item appears only if you select SBAS as the correction type.
NMEA Port Setup	See Chapter 5, "Communicating with Third Party Applications."		
Unit of Measure	Unit of Measure >Feet	[Feet, Meters] Default = Feet	Select desired unit of measure as feet or meters.
Language	Language >English	Default = English	Select desired language. Multiple languages are supported.
	Language options vary depending on the language group installed on your S-Lite. Contact Outback Guidance Customer Service for questions regarding language groups.		
Reset Defaults	Reset Defaults ENTER to Reset		Select this option to reset factory defaults.



Chapter 3: Using Guidance Features

Guidance Overview

Status Indicators

Main Run Display Screens

Additional Display Screens

Using Straight Guidance

Using Contour Guidance

Calculating the Area of a Field

Stopping Guidance

Guidance Overview

Figure 3-1 points out the features of the S-Lite console.

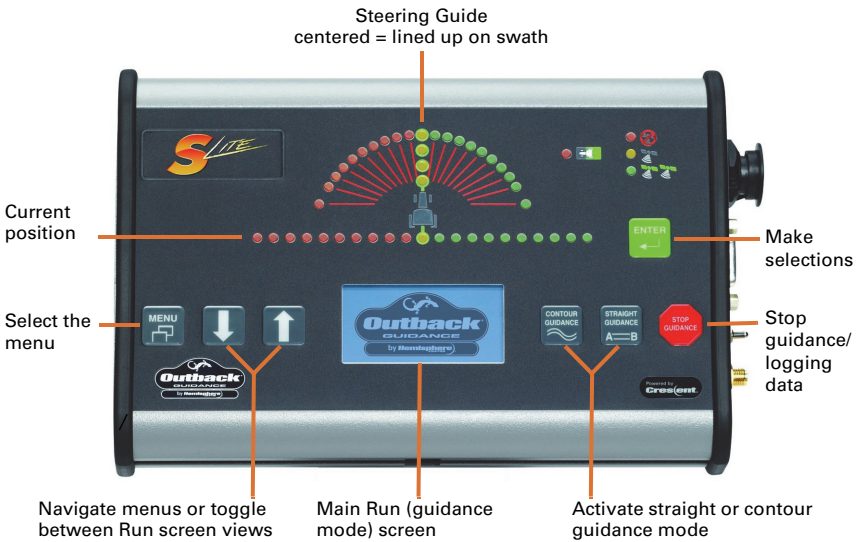

Figure 3-1: S-Lite console features

S-Lite provides two main guidance options:



Straight guidance
 Predefined parallel passes; you can drive linear or circular passes.



Contour guidance
 Freestyle guidance; you can drive freestyle passes relative to any previous pass.

Table 3-1 summarizes Straight and Contour guidance mode features. In addition to the two main guidance options, you can calculate the area of a field in contour mode.

Note: It is important to press the STOP GUIDANCE button whenever S-Lite is not guiding. During guidance, S-Lite records all movement. Pressing STOP GUIDANCE tells S-Lite not to guide and not to record movement.

Table 3-1: Straight and Contour guidance summary

Item	Straight Mode	Contour Mode
Mode of Operation	Predefined parallel and numbered passes. Passes can be straight or circular.	Freestyle. Guide relative to any previous pass.
Work Recorded in Memory	Yes. Although recorded work in Straight mode is not used for guidance, it is used if you switch to Contour mode and then want to make a pass along previous work.	Yes. The recorded pass defines where the next pass is guided.

Table 3-1: Straight and Contour guidance summary (continued)

Item	Straight Mode	Contour Mode
A=B Points Required	Yes. The A=B defines the first pass and then all other passes are laid out automatically.	No. Guidance is based on previous passes.
Guides from Previous Pass	No. Straight guidance only looks at predefined parallel lines spaced by the width of the implement, as entered in the Swath Width menu.	Yes. Once S-Lite “sees” another previous pass close by, it automatically begins to guide on that pass. Wherever the previous pass goes guides the next pass.
Numbered Passes	Yes. The first A=B line is pass #0. Passes to the right increment +1, +2, etc. and passes to the left decrement -1, -2, etc.	No
Swath Width Integrity Across the Field	Yes. Since guidance is always looking at predetermined parallel lines, all passes will be in perfect multiples of the swath width. This works well when planting, harvesting, ditching, and furrowing.	No. Since guidance is always working from the last pass, driving errors add as the vehicle works across the field. Each pass redefines the next pass.
Switching Modes	Yes. You can switch from Straight to Contour mode at any time. Contour mode recognizes passes previously done in Straight mode.	Yes. You can switch S-Lite guidance modes by pressing the STRAIGHT GUIDANCE or CONTOUR GUIDANCE buttons. When switching to Straight mode, you have the option of using a previously defined A=B line, or setting a new one.
Skip Passes?	Yes. You can complete passes in any order desired. They will still be uniformly spaced across the field.	If you skip an area, S-Lite recognizes it as a new pass and continues logging. S-Lite can either guide off the new pass or continue guiding off the old passes.

Status Indicators

The Headland Alert indicator lights when the vehicle crosses into a previously applied area.

Headland —



Main Run Display Screens

The S-Lite has two main run display screens: the Straight Guidance Mode screen and the Contour Guidance Mode screen (shown below). You can access additional display screens from these main run screens.

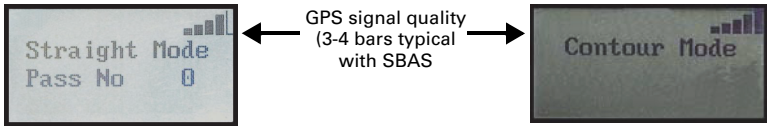

Straight Guidance display message

Contour Guidance display message

Additional Display Screens

While operating in either Straight or Contour guidance modes, the arrow keys present additional display screens. Repeatedly pressing the DOWN ARROW button displays the following screens; repeatedly pressing the UP ARROW displays the same screens in the reverse order.

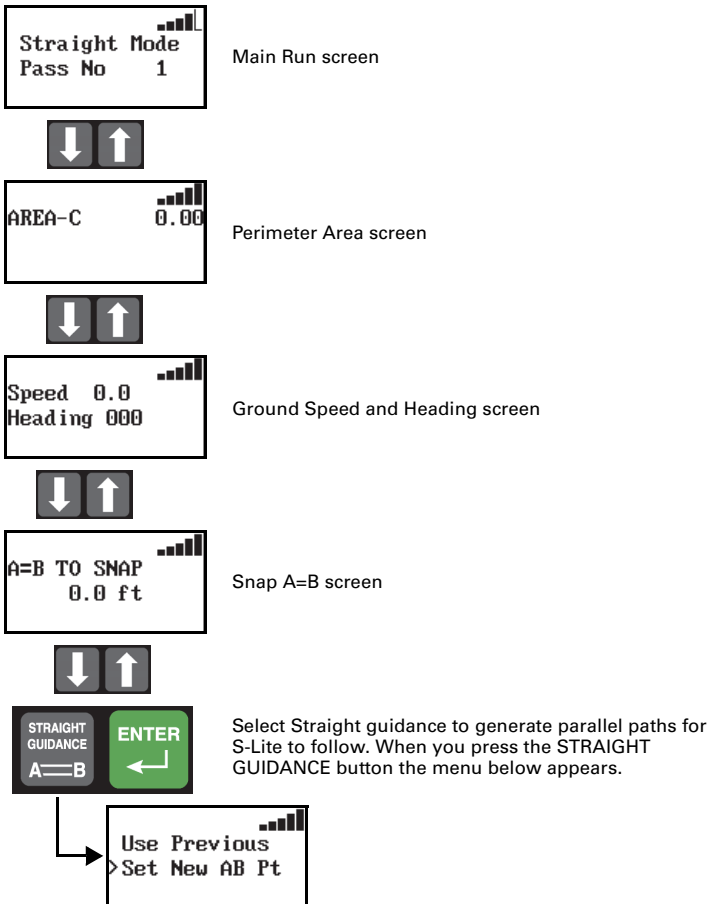

Using Straight Guidance

The first pass can either be established along a straight side of the field, or it can divide the field with a straight swath working out each side. Either way, all passes will be perfectly and uniformly spaced across the field.

Setting the A=B Line

The A=B line is an imaginary line that passes through two points to define the first pass. All other passes are perfectly spaced on both sides of the first pass.

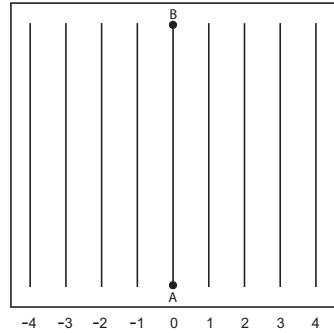

Marking Point A and Point B While Driving

1. Position the vehicle at the beginning of the first pass.
2. Press the **STRAIGHT GUIDANCE** button.
3. Select **SET NEW AB** on the display screen and press the ENTER button.
4. Press the **ENTER** button to mark Point A.
5. Drive the first pass.
6. At the end of the pass, press the **ENTER** button to mark Point B.

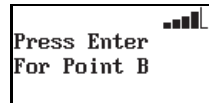
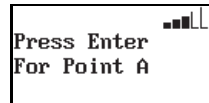
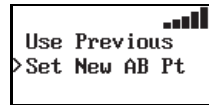

Begin Straight Guidance

After setting the A=B line, S-Lite automatically begins guiding.

1. Turn the steering wheel in the direction indicated by the Steering Guide lights to remain centered on the current pass.
2. At the end of the current pass, turn around. S-Lite automatically detects the next pass and begins guiding.

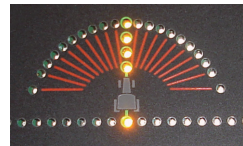

Switching Modes

You can switch S-Lite guidance modes by pressing the STRAIGHT GUIDANCE button or the CONTOUR GUIDANCE button. When you switch to Straight mode for the second time, you have the option to use the previous A=B line or set a new one.

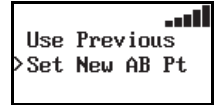

Pass Numbering

Once the A=B line is established, all passes will be numbered. While turning around at the headland, the nearest pass number is displayed. You can work passes in any order.

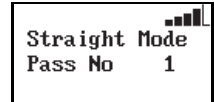

Adjusting the A=B Line

While operating in Straight guidance mode, you can adjust the A=B line on-the-go without interrupting normal guidance operation. This feature is especially useful to correct for DGPS drift over time.

- A=B to Snap:** You can “snap” the A=B line to the vehicle’s current location parallel to the original A=B line. The Snap A=B feature is best used to insert a desired gap between consecutive parallel swaths (such as a conservation barrier strip).

Snapping the A=B line to the current location

- While in Straight guidance mode, press the UP ARROW button once to display the SNAP TO A=B screen.
- Press the STRAIGHT GUIDANCE button. This causes the nearest A=B guide line to be aligned with the current vehicle position (snap A=B to here).
- Press the DOWN ARROW button to return to the Straight guidance screen.

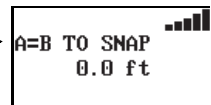

Using Contour Guidance

Select Contour Guidance to follow previous passes. In this mode, the S-Lite is either logging an initial pass or guiding from a previous pass. After selecting Contour guidance, proceed by making the initial pass without using the Steering Guide lights. Later, when attempting to follow a previous pass, the guidance will engage. You generally use Contour Guidance for working out borders, turn areas and contour following.



1. Press CONTOUR GUIDANCE before beginning the initial pass. The display shows "LOGGING PASS"
2. Make the initial pass without using the Steering Guide.
3. At the end of the current pass, turn around and begin the next pass. S-Lite automatically detects the previous pass and begins guiding.



Guiding on Subsequent Passes

Anytime the vehicle is within half a swath width of a previously logged pass, the S-Lite automatically begins to guide. In Contour mode, S-Lite can guide from any previous pass, even those made in Straight guidance mode.

Making A New First Pass

Occasionally a situation arises in the middle of a job when a pass will need to be made that follows a different path than the previous passes. Simply drive the new path. Once it becomes obvious that a new pass is being defined, S-Lite goes into logging pass mode. Subsequent passes are guided from this newly defined pass.

Calculating the Area of a Field

At the beginning of each new field, you can use S-Lite to calculate the field perimeter area of the first contour pass around the field.

1. Press **STOP GUIDANCE**.
2. Press the **DOWN ARROW** button.
3. Select **ERASE MEMORY** from the display screen.
4. Press the **ENTER** button.
5. Press the **MENU** button.
6. Select **PERIMETER SETUP** from the display screen.
7. Press the **ENTER** button.
8. Select **RIGHT, LEFT, or CENTER**, to set which swath width position will be used to calculate the perimeter.
9. Press the **ENTER** button.
10. Press the **CONTOUR GUIDANCE** button.
11. Drive the vehicle around the outside edge of the field. The main guidance screen displays "LOGGING PASS".
12. Press the **DOWN ARROW** button to display the perimeter area calculations. The displayed AREA-"x" shows the current perimeter setup selection where "x" is L=left, C=center, or R=right.

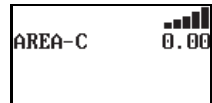
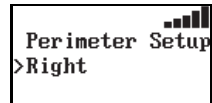

The calculations continuously update until the vehicle is within one swath width of the starting point. S-Lite then automatically closes the perimeter and displays the final calculations.

Note: The units for the area calculation are Acres if the unit of measure is set to Feet, and Hectares if the unit of measure is set to Meters.

Stopping Guidance

It is important to use the Stop Guidance feature whenever S-Lite is not guiding. During guidance, the S-Lite records all movement. Pressing the STOP GUIDANCE button tells S-Lite not to guide and not to record movement. Table 3-2 provides a summary of Stop Guidance features.

Table 3-2: Stop Guidance feature summary

Feature	Description
Hold	Stops logging. Use during turns or to relocate.
RETURN HERE	Saves the job and the ending point for later return.
RTRN PREV PT	Starts guidance to take you back to a previously saved point.
UPDATE e-Dif	Optional menu item if the correction type is set to e-Dif. Resets e-Dif correction to match current position with previous return point. <i>Note: Hemisphere's patented Extended Differential (e-Dif®) software enables S-Lite to perform with differential-like accuracy for extended periods of time without the use of a differential service. See "Using e-Dif" on page 29 for information on e-Dif.</i>
ERASE MEMORY	Clears memory in preparation of a new job.

Hold Logging Data/Guiding

Use the Hold feature to stop logging data during turns or to relocate to another section of the field.

1. Press **STOP GUIDANCE**. Do not select any available menu items.
2. To resume guiding and logging data, press **STRAIGHT GUIDANCE** or **CONTOUR GUIDANCE**.

S-Lite prompts to use the previously defined A=B line.

3. Press **ENTER** to continue with the current job.

Return Here

Use the Return Here function to suspend application in order to reload or at the end the day. It saves the job and records the end point, allowing S-Lite to restart exactly where it left off.

1. Press **STOP GUIDANCE**.
2. Select RETURN HERE on the screen and press **ENTER**.

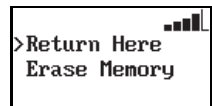

3. Press **STRAIGHT GUIDANCE** or **CONTOUR GUIDANCE**.

S-Lite prompts to use the previously defined A=B line.

4. Press **ENTER** to continue with the current job.

Return to Previous Point

Using the Return to Previous Point function to have S-Lite guide back to a previously saved point.

1. Press **STOP GUIDANCE**.
2. Select **RTRN PREV PT** and press **ENTER**. S-Lite guides to the saved point.
3. At the saved point, press **STRAIGHT GUIDANCE** or **CONTOUR GUIDANCE**.
S-Lite prompts to use the previously defined A=B line.
4. Press **ENTER** to continue with the current job.

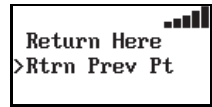

Update e-Dif

The Update e-Dif function is activated when the Correction Type is set to e-Dif. Anytime field operations are suspended (for hours or days) the Update e-Dif function allows guidance to resume without interruption by resetting the e-Dif correction to match the current starting point with the previously recorded return point. See "Using e-Dif" on page 29 for more information on e-Dif.

1. At the end of an application, create a return point using the steps outlined in "Return Here" on page 25. In addition, establish a physical mark in the field corresponding to the ending position. The physical mark should be easy to drive back to at a future time.
2. When resuming the application, return to the ending position. You may use the Return to Previous Point function (above, up to step 4) to get nearby, but it is important to return to the same physical location.
3. After returning to the ending position, press **STOP GUIDANCE**.
4. Select **UPDATE E-DIF** from the displayed menu.
5. Press **ENTER**.

Note: S-Lite displays "UPDATE OK" if the corrections have reset properly. If S-Lite encounters an error in resetting the corrections, it displays "NOT YET UPDATED."

6. Resume guidance by pressing **STRAIGHT GUIDANCE** or **CONTOUR GUIDANCE**.

Erase Memory

The Erase Memory function removes all recorded passes and points for the job to prepare for a new job. You normally do this at the end of each field.

There are 30.56 hours of total memory available. If you do not erase memory between fields, it will fill up. If this happens, a "MEMORY FULL" message appears. Use the ERASE MEMORY function to clear the memory.

1. Press **STOP GUIDANCE**.
2. Select **ERASE MEMORY**.
3. Press **ENTER**.
All data is erased and you are returned to the menu.

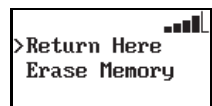



Chapter 4: Differential Correction Types

Differential Corrections Overview
Using e-Dif

Differential Corrections Overview

The differential correction type used by S-Lite is selected from the two GPS applications loaded into the receiver. You can change the correction type from the CORRECTION TYPE item in the Service menu (see “Service Menu” on page 15). Select SBAS, e-Dif, or other field-installed correction option(s).

- For North American distribution, SBAS (WAAS) is the factory installed option. WAAS is free and is available throughout most of North America.
- For European distribution, SBAS (EGNOS) is the factory installed option. EGNOS, like WAAS, is also free and is available throughout most of Europe.
- For all other locations that do not have access to SBAS corrections like WAAS or EGNOS, e-Dif is the factory installed option. Use of e-Dif requires no additional hardware.

Note: e-Dif, as factory installed, is pre-activated with a one-time primary subscription for use anywhere in the world. The use of e-Dif on Outback Guidance equipment as a GPS differential correction is intended only for relative guidance applications and is not recommended for data recording and subsequent comparative analysis. Relative positional accuracy will typically drift at a rate of 1-2 meters (3-6.5 feet) per hour; however, absolute positional accuracy errors may approach ± 10 meters (± 33 feet).

Using e-Dif

The patented e-Dif correction method uses only the standard GPS satellites and does not require an external correction signal of any type.

e-Dif works by analyzing the error trends from the GPS satellites and projects new correction values into the future. This technique is stable and accurate within short time frames making it perfect for progressive pass-to-pass guidance. As long as each pass is within a few minutes of the last pass, the accuracy performance is excellent.

Selecting e-Dif

To configure S-Lite for use with e-Dif: select e-Dif as the correction type on the Service menu.

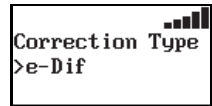

To then use S-Lite with e-Dif: follow the general directions in this manual, but review the following section first regarding power on initialization and DGPS lock.

Power On Initialization and DGPS Lock

After powerup, S-Lite must track GPS satellites for up to 10 minutes before generating differential corrections. The vehicle may be moving or stationary during this time.

- While tracking, the yellow GPS LED illuminates and the display shows the number of satellites being tracked ('Tracking 8 Sats' shown at right).

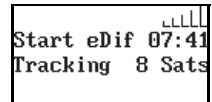

- When S-Lite is finished tracking, the green DGPS LED illuminates and the display indicates ready ('Ready - 9 Sats' shown at right).

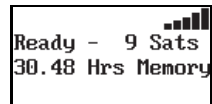



Chapter 5: Communicating with Third Party Applications

Available Applications
Changing Default Settings

Available Applications

The DGPS signals of S-Lite can be shared with third-party mobile applications.

Any application designed to receive DGPS signals from an external receiver over an RS-232 serial interface using NMEA 0183 messages will work with S-Lite. Various connecting cables and kits are available for such applications as yield monitors, rate controllers, laptops, PDAs, etc.

For successful communication, you must configure both the S-Lite console and the external application to communicate in the same way. Many applications can use the default communication protocol; however, some applications may require alteration from the default settings.

Changing Default Settings

You can change the default communication settings from the NMEA PORT SETUP item in the S-Lite Service menu.

- To change the NMEA message, select NMEA PORT SETUP.
- To change the baud rate, select NMEA PORT BAUD.

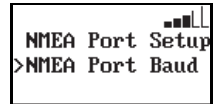

The following options are available (default options are in bold):

1. NMEA PORT BAUD: 19200, 9600, **4800**.
2. GGA RATE: OFF, 2 HZ, **1 HZ**, 5 HZ
3. GLL RATE: **OFF**, 2 HZ, 1 HZ, 5 HZ
4. VTG RATE: OFF, 2 HZ, **1 HZ**, 5 HZ
5. RMC RATE: **OFF**, 2 HZ, 1 HZ, 5 HZ
6. GSA RATE: **OFF**, 2 HZ, 1 HZ, 5 HZ
7. ZDA RATE: **OFF**, 2 HZ, 1 HZ, 5 HZ

Note: If the higher rate of 5 HZ is selected then a faster NMEA PORT BAUD rate should also be selected (ex. 19200) to facilitate proper communication.



Appendix A: Troubleshooting

Diagnostics

Troubleshooting

Testing Antenna Voltage

Checking the DGPS Position by Verifying the BER

Diagnostics

Table A-1 provides helpful S-Lite operating/troubleshooting information.

Table A-1: Helpful operating and troubleshooting information

Item	Description
CORRECTION TYPE	Displays the type of differential correction being used. There are two GPS applications loaded into the receiver. SBAS is the factory installed default, while you may select e-Dif for use where SBAS is not available.
SATS: TRK=08 USE IN CALC=08	Tells the number of GPS satellites currently visible in the sky (does not include correction satellites).
STDEV	Pseudo-estimate of the DGPS solution accuracy determined as the RMS value of the positional residual errors. STDEV is valid only if 6 or more satellites are used in the solution calculation. Typical values for SBAS correction are 0.15 m - 0.45 m (0.5 ft - 1.5 ft).
HDOP	The Horizontal Dilution of Precision indicates the influence of the current GPS satellite constellation geometry on the horizontal accuracy of the position solution. Lower values of HDOP indicate better geometry. Typical valves are 0.8 - 2.0.
DIFF AGE	This indicates the age of the RTCM corrections used in the DGPS calculation. Optimal operating values are < 7 sec.
BIT ERROR RATE	Relative strength of the correction satellite(s). In the case of WAAS, two numbers are shown separated by a hyphen. The number can be from 0 to 500, with 0 being good and 500 being bad. See page 36 for a more detailed explanation.
GPS SOFTWARE VER	GPS software version.
APP SOFTWARE VER	Application software version.
SERIAL NUMBER	Serial number of your S-Lite. It should match the number on the serial number tag on the back of the console.
MEMORY	Amount of remaining memory (in hours). All passes are recorded in memory until erased at the end of each field. To clear the memory, press the STOP GUIDANCE button and select the ERASE MEMORY menu item.

Troubleshooting

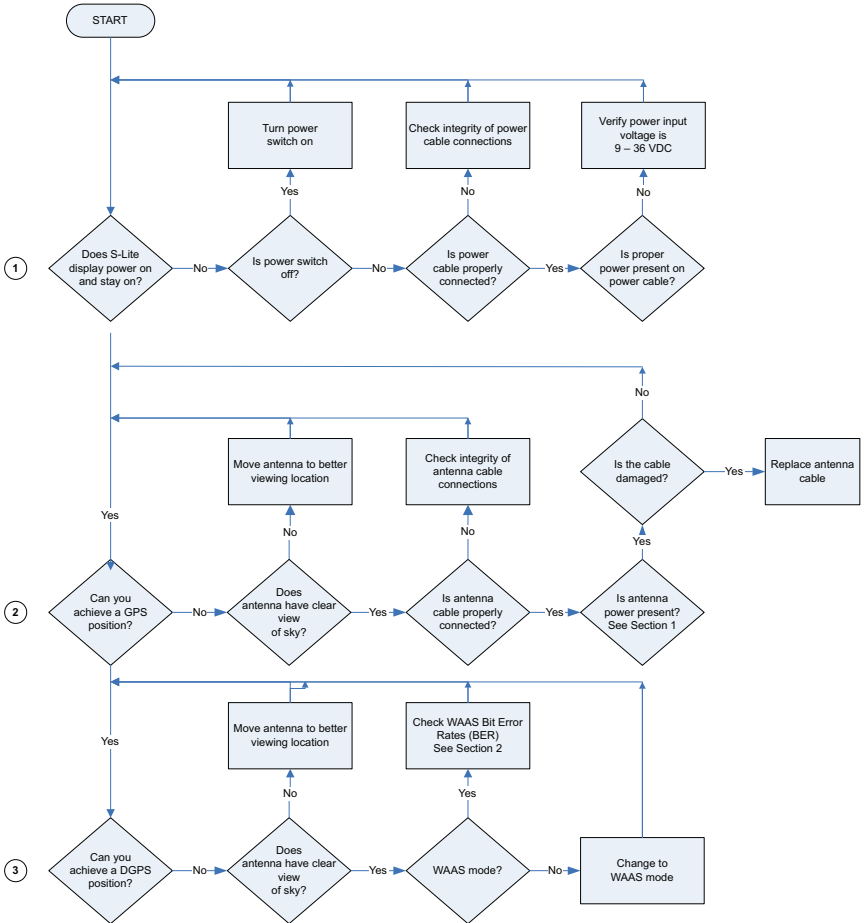

Testing Antenna Voltage

The S-Lite antenna is an “active” antenna that requires power to operate. Power is supplied to the antenna via the coaxial cable connecting it to the S-Lite console. Testing the antenna voltage can ensure the S-Lite receiver is supplying power to the antenna and can verify the antenna cable is not damaged.

To test antenna voltage:

1. Turn off the S-Lite console and then disconnect the antenna cable from the S-Lite antenna.
2. Turn on the S-Lite console.
3. Using a voltmeter set to VDC, measure the voltage output across the antenna cable. It should measure +5 VDC between the center conductor and exterior connector shell.
 - If the measurement is +5 VDC across the antenna cable, then neither the cable nor the receiver is damaged (antenna voltage test complete).
 - If the measurement is not +5 VDC across the antenna cable, go to step 4.
4. Turn off the S-Lite console and then disconnect the antenna cable from the S-Lite console.
5. Turn on the S-Lite console.
6. Using a voltmeter set to VDC, measure the voltage output across the antenna output on the console. It should measure +5 VDC between the center conductor and exterior housing.
 - If the measurement is +5 VDC at the console connector, but not at the end of the antenna cable, the cable is damaged. Replace the antenna cable and return to step 1.
 - If the measurement is not +5 VDC from the S-Lite console, contact Outback Customer Service to return the console for servicing.

Checking the DGPS Position by Verifying the BER

You can check the bit error rate (BER) via the BER value on the Diagnostics menu.

BER is a check of correction signal reception quality and is based on a scale of 0 to 500. BER < 20 is ideal. If BER > 20 verify the antenna has a clear view of the sky to properly find and track correction satellites. When using SBAS for the correction type, S-Lite tracks one or two correction satellites. Each satellite has a different BER and the BER value on the Diagnostics menu represents the values separated by a hyphen.

For example, a value of 8-500 means the S-Lite has a very good signal on one satellite (BER=8) and is not receiving corrections from the other satellite (BER=500, the lowest reception value). Only one satellite must have a low BER value (less than 20) to provide differential corrections.

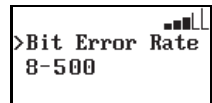



Appendix B: Menu Map

Below is a list of all S-Lite menu items. Access to various menu items depends on the application and/or S-Lite components being used.

<u>Setup Menu</u>	
Brightness	5
Swath Width	30.00
Sensitivity	Medium
Perimeter Setup	Right
Diagnostics	>
Service Menu	>

<u>Diagnostics</u>	
Correction Type	SBAS
Sats	Trk=10, Use in Cal=09
STDEV	0.04 ft
HDOP	1.20
Diff Age	0001 secs
Bit Rate Error	0-0
GPS Software	Ver. 6.8
App Software	Ver. 1.0
Serial Number	300556
Memory	29.87 hr./98% Free

<u>Service Menu</u>	
Correction Type	SBAS
SBAS Satellite	AUTO
NMEA Port Setup	>
Unit of Measure	Feet
Language	English
Reset Defaults	>

<u>NMEA Port Setup</u>	
NMEA Port Setup	
NMEA Port Baud	4800
GGA	1 Hz
GLL	Off
VTG	1 Hz
RMC	Off
GSA	Off
ZDA	Off

Index

A

- A=B line
 - adjusting 22
 - setting in straight guidance 21
 - snapping to current location 22
- adjusting the A=B line 22
- antenna
 - mounting 10
 - routing 12
- applications available 32

B

- battery safety 3
- beginning straight guidance 21

C

- calculating the area of a field 24
- changing default settings 32
- checking
 - power (troubleshooting) 36
- collisions safety 2
- configuring S-Lite 14
- contour guidance 18, 23
 - guiding on subsequent passes 23
 - making a new first pass 23
 - summary 18

D

- default settings (changing) 32
- diagnostics 34
- differential corrections 28
 - e-Dif 29
 - selecting e-Dif 29
- display screens
 - additional 20
 - main run 20

E

- e-Dif 29
 - power on and DGPS lock information 29
 - selecting 29
- Erase Memory function 26
- erasing memory 26

G

- guidance
 - calculating the area of a field 24

- contour 18
- Erase Memory function 26
- hold logging data/guiding 25
- Return Here function 25
- Return to Previous Point function 26
- status indicators 19
- stopping 25
- straight 18
- summary 18
- switching modes 22
- Update e-Dif function 26
- guiding on subsequent passes (contour guidance) 23

H

- headland alert indicator 19
- hold logging data/guiding 25

I

- installation safety 2
- installing
 - mounting the antenna 10
 - overview 10
 - routing antenna 12

M

- making a new first pass (contour guidance) 23
- manual override safety 2
- marking A and B points (straight guidance) 21
- memory (erasing) 26
- menu map 38
- menus
 - Service menu 15
 - Setup menu 14
 - using 14
- mounting
 - antenna 10
- mounting safety 3

O

- operation (of S-Lite) safety 3
- operator position safety 2
- operator safety 2
- overview of S-Lite 6

P

- parts
 - list 6
 - photo 6
- pass numbering (straight guidance) 22

R

- Return Here function 25
- Return to Previous Point function 26
- routing
 - antenna 12

S

- safety information 2
- selecting e-Dif 29
- Service menu 15
- setting the A=B line (straight guidance) 21
- Setup menu 14
- S-Lite
 - available applications 32
 - changing default settings 32
 - configuring 14
 - installing 10
 - overview 6
 - parts list 6
 - parts photo 6
- snapping the A=B line to current location 22
- status indicators 19
- stopping guidance 25
- straight guidance 18, 21
 - adjusting the A=B line 22
 - beginning straight guidance 21
 - display screen 20
 - marking A and B points 21
 - pass numbering 22
 - setting the A=B line 21
 - snapping the A=B line to current location 22
 - summary 18
- switching guidance modes 22

T

- tractor overturns safety 2
- troubleshooting 35
 - checking power 36

U

- Update e-Dif function 26
- using the menus 14

End User License Agreement

IMPORTANT - This is an agreement (the **"Agreement"**) between you, the end purchaser (**"Licensee"**) and AgJunction, Inc. (**"AgJunction"**) which permits Licensee to use the AgJunction software (the **"Software"**) that accompanies this Agreement. This Software may be licensed on a standalone basis or may be embedded in a Product. Please read and ensure that you understand this Agreement before installing or using the Software Update or using a Product.

In this agreement any product that has Software embedded in it at the time of sale to the Licensee shall be referred to as a **"Product"**. As well, in this Agreement, the use of a Product shall be deemed to be use of the Software which is embedded in the Product.

BY INSTALLING OR USING THE SOFTWARE UPDATE OR THE PRODUCT, LICENSEE THEREBY AGREES TO BE LEGALLY BOUND BY THE TERMS OF THIS AGREEMENT. IF YOU DO NOT AGREE TO THESE TERMS, (I) DO NOT INSTALL OR USE THE SOFTWARE, AND (II) IF YOU ARE INSTALLING AN UPDATE TO THE SOFTWARE, DO NOT INSTALL THE UPDATE AND PROMPTLY DESTROY IT.

AGJUNCTION PROVIDES LIMITED WARRANTIES IN RELATION TO THE SOFTWARE. AS WELL, THOSE WHO USE THE EMBEDDED SOFTWARE DO SO AT THEIR OWN RISK. YOU SHOULD UNDERSTAND THE IMPORTANCE OF THESE AND OTHER LIMITATIONS SET OUT IN THIS AGREEMENT BEFORE INSTALLING OR USING THE SOFTWARE OR THE PRODUCT.

1. **LICENSE.** AgJunction hereby grants to Licensee a non-transferable and non-exclusive license to use the Software as embedded in a Product and all Updates (collectively the **"Software"**), solely in binary executable form.
2. **RESTRICTIONS ON USE.** Licensee agrees that Licensee and its employees will not directly or indirectly, in any manner whatsoever:
 - a. install or use more copies of the Software than the number of copies that have been licensed;
 - b. use or install the Software in connection with any product other than the Product the Software was intended to be used or installed on as set out in the documentation that accompanies the Software;
 - c. copy any of the Software or any written materials for any purpose except as part of Licensee's normal backup processes;
 - d. modify or create derivative works based on the Software;
 - e. sub-license, rent, lease, loan or distribute the Software;
 - f. permit any third party to use the Software;
 - g. use or operate Product for the benefit of any third party in any type of service outsourcing, application service, provider service or service bureau capacity;
 - h. reverse engineer, decompile or disassemble the Software or otherwise reduce it to a human perceivable form;
3. **UPDATES.** At AgJunction's discretion AgJunction may make Updates available to Licensee. An update (**"Update"**) means any update to the Software that is made available to Licensee including error corrections, enhancements and other modifications. Licensee may access, download and install Updates during the Warranty Period only. All Updates that Licensee downloads, installs or uses shall be deemed to be Software and subject to this Agreement. AgJunction reserves the right to modify the Product without any obligation to notify, supply or install any improvements or alterations to existing Software.
4. **SUPPORT.** AgJunction may make available directly or through its authorized dealers telephone and email support for the Software. Contact AgJunction to find the authorized dealer near you. As well, AgJunction may make available user and technical documentation regarding the Software. AgJunction reserves the right to reduce and limit access to such support at any time.
5. **BACKUPS AND RECOVERY.** Licensee shall back up all data used, created or stored by the Software on a regular basis as necessary to enable proper recovery of the data and related systems and processes in the event of a malfunction in the Software or any loss or corruption of data caused by the Software. Licensee shall assume all risks of loss or damage for any failure to comply with the foregoing.
6. **OWNERSHIP.** AgJunction and its suppliers own all rights, title and interest in and to the Software and related materials, including all intellectual property rights. The Software is licensed to Licensee, not sold.
7. **TRADEMARKS.** "AgJunction", "Outback Guidance", "Satloc" and the associated logos are trademarks of AgJunction. Other trademarks are the property of their respective owners. Licensee may not use any of these trademarks without the consent of their respective owners.
8. **LIMITED WARRANTY.** AgJunction warrants solely to the Licensee, subject to the exclusions and procedures set forth herein below, that for a period of one (1) year from the original date of purchase of the Product in which it is embedded (the **"Warranty Period"**), the Software, under normal use and maintenance, will conform in all material respects to the documentation provided with the Software and any media will be free of defects in materials and workmanship. For any Update, AgJunction warrants, for 90 days from performance or delivery, or for the balance of the original Warranty Period, whichever is greater, that the Update, under normal use and maintenance, will conform in all material respects to the documentation provided with the Update and any media will be free of defects in materials and workmanship. Notwithstanding the foregoing, AgJunction does not warrant that the Software will meet Licensee's requirements or that its operation will be error free.
9. **WARRANTY EXCLUSIONS.** The warranty set forth in Section (8) will not apply to any deficiencies caused by (a) the Product not being used as described in the documentation supplied to Licensee, (b) the Software having been altered, modified or converted in any way by anyone other than AgJunction or approved by AgJunction, (c) any malfunction of Licensee's equipment or other software, or (d) damage occurring in transit or due to any accident, abuse, misuse, improper installation, lightning (or other electrical discharge) or neglect other than that caused by AgJunction. AgJunction does not warrant or guarantee the precision or accuracy of positions obtained when using the Software (whether standalone or embedded in a Product). The Product and the Software is not intended and should not be used as the primary means of navigation or for use in safety of life applications. The potential

positioning and navigation accuracy obtainable with the Software as stated in the Product or Software documentation serves to provide only an estimate of achievable accuracy based on specifications provided by the US Department of Defense for GPS positioning and DGPS service provider performance specifications, where applicable.

10. **WARRANTY DISCLAIMER.** EXCEPT AS EXPRESSLY SET OUT IN THIS AGREEMENT, AGJUNCTION MAKES NO REPRESENTATION, WARRANTY OR CONDITION OF ANY KIND TO LICENSEE, WHETHER VERBAL OR WRITTEN AND HEREBY DISCLAIMS ALL REPRESENTATIONS, WARRANTIES AND CONDITIONS OF ANY KIND INCLUDING FITNESS FOR A PARTICULAR PURPOSE, MERCHANTABILITY, ACCURACY, RELIABILITY OR THAT THE USE OF THE SOFTWARE WILL BE UNINTERRUPTED OR ERROR-FREE AND HEREBY DISCLAIMS ALL REPRESENTATIONS, WARRANTIES AND CONDITIONS ARISING AS A RESULT OF CUSTOM, USAGE OR TRADE AND THOSE ARISING UNDER STATUTE.
11. **LIMITS ON WARRANTY DISCLAIMER.** Some jurisdictions do not allow the exclusion of implied warranties or conditions, so some of the above exclusions may not apply to Licensee. In that case, any implied warranties or conditions which would then otherwise arise will be limited in duration to ninety (90) days from the date of the license of the Software or the purchase of the Product. The warranties given herein give Licensee specific legal rights and Licensee may have other rights which may vary from jurisdiction to jurisdiction.
12. **CHANGE TO WARRANTY.** No employee or agent of AgJunction is authorized to change the warranty provided or the limitation or disclaimer of warranty provisions. All such changes will only be effective if pursuant to a separate agreement signed by senior officers of the respective parties.
13. **WARRANTY CLAIM.** In the event Licensee has a warranty claim Licensee must first check for and install all Updates that are made available. The warranty will not otherwise be honored. Proof of purchase may be required. AgJunction does not honor claims asserted after the end of the Warranty Period.
14. **LICENSEE REMEDIES.** In all cases which involve a failure of the Software to conform in any material respect to the documentation during the Warranty Period or a breach of a warranty, AgJunction's sole obligation and liability, and Licensee's sole and exclusive remedy, is for AgJunction, at AgJunction's option, to (a) repair the Software, (b) replace the Software with software conforming to the documentation, or (c) if AgJunction is unable, on a reasonable commercial basis, to repair the Software or to replace the Software with conforming software within ninety (90) days, to terminate this Agreement and thereafter Licensee shall cease using the Software. AgJunction will also issue a refund for the price paid by Licensee less an amount on account of amortization, calculated on a straight-line basis over a deemed useful life of three (3) years.
15. **LIMITATION OF LIABILITY.** IN NO EVENT WILL AGJUNCTION BE LIABLE TO LICENSEE FOR ANY INCIDENTAL, CONSEQUENTIAL, SPECIAL OR INDIRECT DAMAGES INCLUDING ARISING IN RELATION TO ANY LOSS OF DATA, INCOME, REVENUE, GOODWILL OR ANTICIPATED SAVINGS EVEN IF AGJUNCTION HAS BEEN INFORMED OF THE POSSIBILITY OF SUCH LOSS OR DAMAGE. FURTHER, IN NO EVENT WILL AGJUNCTION'S TOTAL CUMULATIVE LIABILITY HEREUNDER, FROM ALL CAUSES OF ACTION OF ANY KIND, EXCEED THE TOTAL AMOUNT PAID BY LICENSEE TO AGJUNCTION TO PURCHASE THE PRODUCT. THIS LIMITATION AND EXCLUSION APPLIES IRRESPECTIVE OF THE CAUSE OF ACTION, INCLUDING BUT NOT LIMITED TO BREACH OF CONTRACT, NEGLIGENCE, STRICT LIABILITY, TORT, BREACH OF WARRANTY, MISREPRESENTATION OR ANY OTHER LEGAL THEORY AND WILL SURVIVE A FUNDAMENTAL BREACH.
16. **LIMITS ON LIMITATION OF LIABILITY.** Some jurisdictions do not allow for the limitation or exclusion of liability for incidental or consequential damages, so the above limitation or exclusion may not apply to Licensee and Licensee may also have other legal rights which may vary from jurisdiction to jurisdiction.
17. **BASIS OF BARGAIN.** Licensee agrees and acknowledges that AgJunction has set its prices and the parties have entered into this Agreement in reliance on the limited warranties, warranty disclaimers and limitations of liability set forth herein, that the same reflect an agreed-to allocation of risk between the parties (including the risk that a remedy may fail of its essential purpose and cause consequential loss), and that the same forms an essential basis of the bargain between the parties. Licensee agrees and acknowledges that AgJunction would not have been able to sell the Product at the amount charged on an economic basis without such limitations.
18. **PROPRIETARY RIGHTS INDEMNITY.** AgJunction shall indemnify, defend and hold harmless Licensee from and against any and all actions, claims, demands, proceedings, liabilities, direct damages, judgments, settlements, fines, penalties, costs and expenses, including royalties and attorneys' fees and related costs, in connection with or arising out of any actual infringement of any third party patent, copyright or other intellectual property right by the Software or by its use, in accordance with this Agreement and documentation, PROVIDED THAT: (a) AgJunction has the right to assume full control over any action, claim, demand or proceeding, (b) Licensee shall promptly notify AgJunction of any such action, claim, demand, or proceeding, and (c) Licensee shall give AgJunction such reasonable assistance and tangible material as is reasonably available to Licensee for the defense of the action, claim, demand or proceeding. Licensee shall not settle or compromise any of same for which AgJunction has agreed to assume responsibility without AgJunction's prior written consent. Licensee may, at its sole cost and expense, retain separate counsel from the counsel utilized or retained by AgJunction.
19. **INFRINGEMENT.** If use of the Software may be enjoined due to a claim of infringement by a third party then, at its sole discretion and expense, AgJunction may do one of the following: (a) negotiate a license or other agreement so that the Product is no longer subject to such a potential claim, (b) modify the Product so that it becomes non-infringing, provided such modification can be accomplished without materially affecting the performance and functionality of the Product, (c) replace the Software, or the Product, with non-infringing software, or product, of equal or better performance and quality, or (d) if none of the foregoing can be done on a commercially reasonable basis, terminate this license and Licensee shall stop using the Product and AgJunction shall refund the price paid by Licensee less an amount on account of amortization, calculated on a straight-line basis over a deemed useful life of three (3) years.
The foregoing sets out the entire liability of AgJunction and the sole obligations of AgJunction to Licensee in respect of any claim that the Software or its use infringes any third party rights.
20. **INDEMNIFICATION.** Except in relation to an infringement action, Licensee shall indemnify and hold AgJunction harmless from any and all claims, damages, losses, liabilities, costs and expenses (including reasonable fees of lawyers and other professionals) arising out of or in connection with Licensee's use of the Product, whether direct or indirect, including without limiting the foregoing, loss of data, loss of profit or business interruption.

21. **TERMINATION.** Licensee may terminate this Agreement at any time without cause. AgJunction may terminate this Agreement on 30 days notice to Licensee if Licensee fails to materially comply with each provision of this Agreement unless such default is cured within the 30 days. Any such termination by a party shall be in addition to and without prejudice to such rights and remedies as may be available, including injunction and other equitable remedies. Upon receipt by Licensee of written notice of termination from AgJunction or termination by Licensee, Licensee shall at the end of any notice period (a) cease using the Software; and (b) return to AgJunction (or destroy and provide a certificate of a Senior Officer attesting to such destruction) the Software and all related material and any magnetic or optical media provided to Licensee. The provisions of Sections 6), 7), 8), 9), 10), 15), 21), 26) and 27) herein shall survive the expiration or termination of this Agreement for any reason.
22. **EXPORT RESTRICTIONS.** Licensee agrees that Licensee will comply with all export control legislation of Canada, the United States, Australia and any other applicable country's laws and regulations, whether under the Arms Export Control Act, the International Traffic in Arms Regulations, the Export Administration Regulations, the regulations of the United States Departments of Commerce, State, and Treasury, or otherwise as well as the export control legislation of all other countries.
23. **PRODUCT COMPONENTS.** The Product may contain third party components. Those third party components may be subject to additional terms and conditions. Licensee is required to agree to those terms and conditions in order to use the Product.
24. **FORCE MAJEURE EVENT.** Neither party will have the right to claim damages as a result of the other's inability to perform or any delay in performance due to unforeseeable circumstances beyond its reasonable control, such as labor disputes, strikes, lockouts, war, riot, insurrection, epidemic, Internet virus attack, Internet failure, supplier failure, act of God, or governmental action not the fault of the non-performing party.
25. **FORUM FOR DISPUTES.** The parties agree that the courts located in the State of Kansas and the courts of appeal there from will have exclusive jurisdiction to resolve any disputes between Licensee and AgJunction concerning this Agreement or Licensee's use or inability to use the Software and the parties hereby irrevocably agree to attorn to the jurisdiction of those courts. Notwithstanding the foregoing, either party may apply to any court of competent jurisdiction for injunctive relief.
26. **APPLICABLE LAW.** This Agreement shall be governed by the laws of the State of Kansas, exclusive of any of its choice of law and conflicts of law jurisprudence.
27. **CISG.** The United Nations Convention on Contracts for the International Sale of Goods will not apply to this Agreement or any transaction hereunder.
28. **GENERAL.** This is the entire agreement between Licensee and AgJunction relating to the Product and Licensee's use of the same, and supersedes all prior, collateral or contemporaneous oral or written representations, warranties or agreements regarding the same. No amendment to or modification of this Agreement will be binding unless in writing and signed by duly authorized representatives of the parties. Any and all terms and conditions set out in any correspondence between the parties or set out in a purchase order which are different from or in addition to the terms and conditions set forth herein, shall have no application and no written notice of same shall be required. In the event that one or more of the provisions of this Agreement is found to be illegal or unenforceable, this Agreement shall not be rendered inoperative but the remaining provisions shall continue in full force and effect.

Warranty Notice

COVERED PRODUCTS: This warranty covers all products manufactured by AgJunction, Inc. (“AgJunction”) and purchased by the end purchaser (the “Products”), unless otherwise specifically and expressly agreed in writing by AgJunction.

LIMITED WARRANTY: AgJunction, Inc. warrants solely to the end purchaser of the Products, subject to the exclusions and procedures set forth below, that the Products sold to such end purchaser and its internal components shall be free, under normal use and maintenance, from defects in materials, and workmanship and will substantially conform to AgJunction’s applicable specifications for the Product, for a period of 12 months from delivery of such Product to such end purchaser (the “Warranty Period”). Repairs and replacement components for the Products are warranted, subject to the exclusions and procedures set forth below, to be free, under normal use and maintenance, from defects in material and workmanship, and will substantially conform to AgJunction’s applicable specifications for the Product, for 90 days from performance or delivery, or for the balance of the original Warranty Period, whichever is greater.

EXCLUSION OF ALL OTHER WARRANTIES. The LIMITED WARRANTY shall apply only if the Product is properly and correctly installed, configured, interfaced, maintained, stored, and operated in accordance with AgJunction’s relevant User’s Manual and Specifications, AND the Product is not modified or misused. The Product is provided “AS IS” and the implied warranties of MERCHANTABILITY and FITNESS FOR A PARTICULAR PURPOSE and ALL OTHER WARRANTIES, express, implied or arising by statute, by course of dealing or by trade usage, in connection with the design, sale, installation, service or use of any products or any component thereof, are EXCLUDED from this transaction and shall not apply to the Product. The LIMITED WARRANTY is IN LIEU OF any other warranty, express or implied, including but not limited to, any warranty of MERCHANTABILITY or FITNESS FOR A PARTICULAR PURPOSE, title, and non-infringement.

LIMITATION OF REMEDIES. The purchaser’s EXCLUSIVE REMEDY against AgJunction shall be, at AgJunction’s option, the repair or replacement of any defective Product or components thereof. The purchaser shall notify AgJunction or an AgJunction approved service center immediately of any defect. Repairs shall be made through an AgJunction approved service center only. Repair, modification or service of AgJunction products by any party other than an AgJunction approved service center shall render this warranty null and void. The remedy in this paragraph shall only be applied in the event that the Product is properly and correctly installed, configured, interfaced, maintained, stored, and operated in accordance with AgJunction’s relevant User’s Manual and Specifications, AND the Product is not modified or misused. NO OTHER REMEDY (INCLUDING, BUT NOT LIMITED TO, SPECIAL, INDIRECT, INCIDENTAL, CONSEQUENTIAL OR CONTINGENT DAMAGES FOR LOST PROFITS, LOST SALES, INJURY TO PERSON OR PROPERTY, OR ANY OTHER INCIDENTAL OR CONSEQUENTIAL LOSS) SHALL BE AVAILABLE TO PURCHASER, even if AgJunction has been advised of the possibility of such damages. Without limiting the foregoing, AgJunction shall not be liable for any damages of any kind resulting from installation, use, quality, performance or accuracy of any Product.

AGJUNCTION IS NOT RESPONSIBLE FOR PURCHASER’S NEGLIGENCE OR UNAUTHORIZED USES OF THE PRODUCT. IN NO EVENT SHALL AGJUNCTION BE IN ANY WAY RESPONSIBLE FOR ANY DAMAGES RESULTING FROM PURCHASER’S OWN NEGLIGENCE, OR FROM OPERATION OF THE PRODUCT IN ANY WAY OTHER THAN AS SPECIFIED IN AGJUNCTION’S RELEVANT USER’S MANUAL AND SPECIFICATIONS. AgJunction is NOT RESPONSIBLE for defects or performance problems resulting from (1) misuse, abuse, improper installation, neglect of Product; (2) the utilization of the Product with hardware or software products, information, data, systems, interfaces or devices not made, supplied or specified by AgJunction; (3) the operation of the Product under any specification other than, or in addition to, the specifications set forth in AgJunction’s relevant User’s Manual and Specifications; (4) damage caused by accident or natural events, such as lightning (or other electrical discharge) or fresh/salt water immersion of Product; (5) damage occurring in transit; (6) normal wear and tear; or (7) the operation or failure of operation of any satellite-based positioning system or differential correction service; or the availability or performance of any satellite-based positioning signal or differential correction signal.

THE PURCHASER IS RESPONSIBLE FOR OPERATING THE VEHICLE SAFELY. The purchaser is solely responsible for the safe operation of the vehicle used in connection with the Product, and for maintaining proper system control settings. UNSAFE DRIVING OR SYSTEM CONTROL SETTINGS CAN RESULT IN PROPERTY DAMAGE, INJURY, OR DEATH. The purchaser is solely responsible for his/her safety and for the safety of others. The purchaser is solely responsible for maintaining control of the automated steering system at all times. THE PURCHASER IS SOLELY RESPONSIBLE FOR ENSURING THE PRODUCT IS PROPERLY AND CORRECTLY INSTALLED, CONFIGURED, INTERFACED, MAINTAINED, STORED, AND OPERATED IN ACCORDANCE WITH AGJUNCTION’S RELEVANT USER’S MANUAL AND SPECIFICATIONS. AgJunction does not warrant or guarantee the positioning and navigation precision or accuracy obtained when using Products. Products are not intended for primary navigation or for use in safety of life applications. The potential accuracy of Products as stated in AgJunction literature and/or Product specifications serves to provide only an estimate of achievable accuracy based on performance specifications provided by the satellite service operator (i.e. US Department of Defense in the case of GPS) and differential correction service provider. AgJunction reserves the right to modify Products without any obligation to notify, supply or install any improvements or alterations to existing Products.

GOVERNING LAW. This agreement and any disputes relating to, concerning or based upon the Product shall be governed by and interpreted in accordance with the laws of the State of Kansas.

OBTAINING WARRANTY SERVICE. In order to obtain warranty service, the end purchaser must bring the Product to an AgJunction approved service center along with the end purchaser’s proof of purchase. AgJunction does not warrant claims asserted after the end of the warranty period. For any questions regarding warranty service or to obtain information regarding the location of an AgJunction approved service center, contact AgJunction at the following address:

AgJunction
2207 Iowa Street
Hiawatha, KS, USA 66434
Phone: (800) 247-3808
Outback Guidance email: outbackCS@outbackguidance.com
Satloc email: satlocsupport@agjunction.com
AgJunction Cloud Services email: support@agjunction.com



www.AgJunction.com